

CHR-2000 series DIN-Rail Type temperature controller

Operation guide

Thank you for purchasing our CHR-2000 series DIN-Rail Type temperature controller. This operation Guide primarily describe the information and knowledge required while using this product. Please read it through to acquire sufficient knowledge before you install and wiring it. Please always keep this guide close to you for reference.

1 Features

- Minitype (22.5*75*94.5) rail mounting, can display.
- With many kinds of input signal, sampling time is 150ms
- The newest AT arithmetic, at thermal systems will not fail calculus
- Have dehumidifier and slope function
- A variety of alarm mode
- Can be choosed PV or SV transfer function
- Optional modbus RTU communications or master-slave communication
- Can be used as temperature, pressure, flow, level, displacement of the test switching control
- Can work with PLC, DCS or other system



CHR-2000

2 Dimension and Panel cut out (unit: mm)

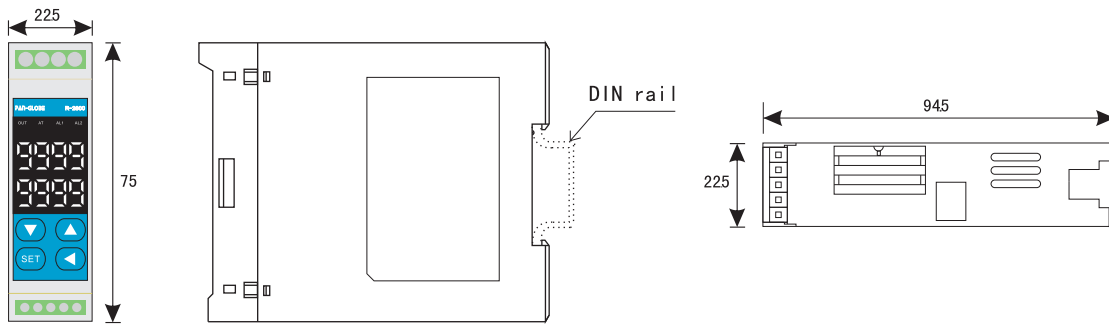

3 Connecting

CHR-2000

AC85-265V
or DC15-50V

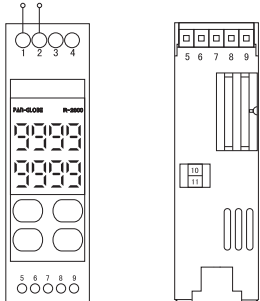

A. input

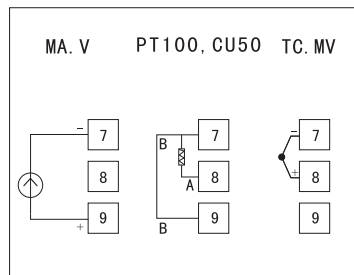

B. control output

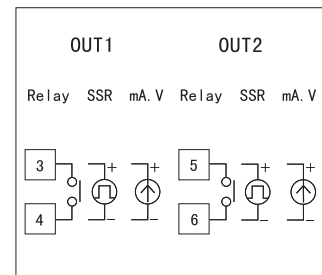

C. alarm

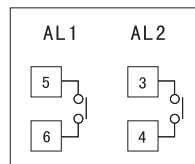

D. Transmission output

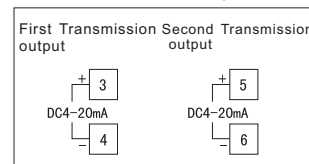

E. Communication

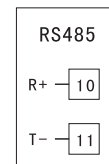

4 Operation instruction



symbol	name	function
PV Upper Display	PV/Parameter indicator	show PV value/ parameter model
SV lower display	SV/Parameter indicator	Show Set Value or present set value
SET	SET Key	Set value, then press SET key to enter shift display parmeter, press shift key
◀	Shift Key	Move sv digit (1digit, 2digit, 3digit, 4digit for a circle)
▼	Down Key	Reduce SV
▲	UP Key	Add SV
OUT	Out1 operation indicator	when out runs, this light on
AT	Auto turing operationindicator	when do automatic tuning, this light on
AL1	Alarm1 indicator	When Alarm1 output, the Ligit on
AL2	Alarm2 indicator	When Alarm2 output, the Ligit on

5 Operation instruction

information displayed after start up

After power supply, operate as following:

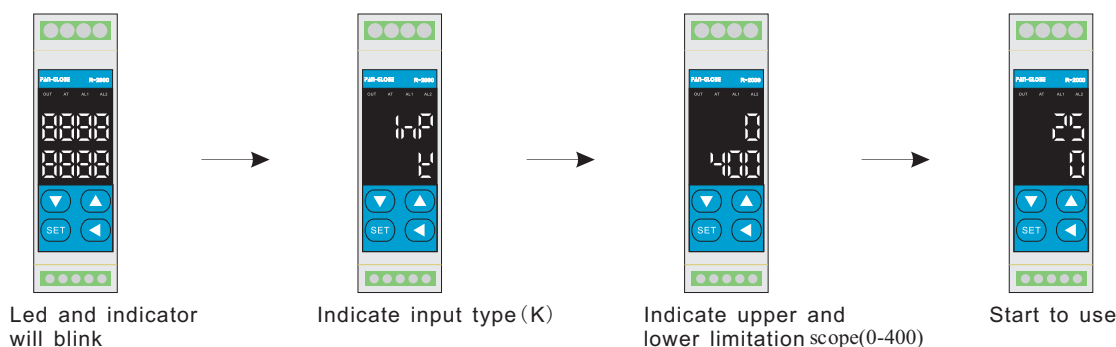

If the following message is displayed, it is not in normal use, please refer to the relevant exclusion method:



Information Description:
The input signal higher than the upper limit USP
Remedy: Check whether the input signal is above the upper limit USP of the controller, input signal is same as input type setting on the controller, or increase the control range limit USP.



Information Description: The input signal is lower than upper limit LSP
Remedy: Check whether the input signal is below the upper limit LSP of the controller, input signal is same as input type setting on the controller, or decrease the control range limit LSP.



Information description: input loop disconnected
Elimination method: please check input connected, thermocouple disconnected or not

input type setting

i.e.: setting input as thermocouple "K"

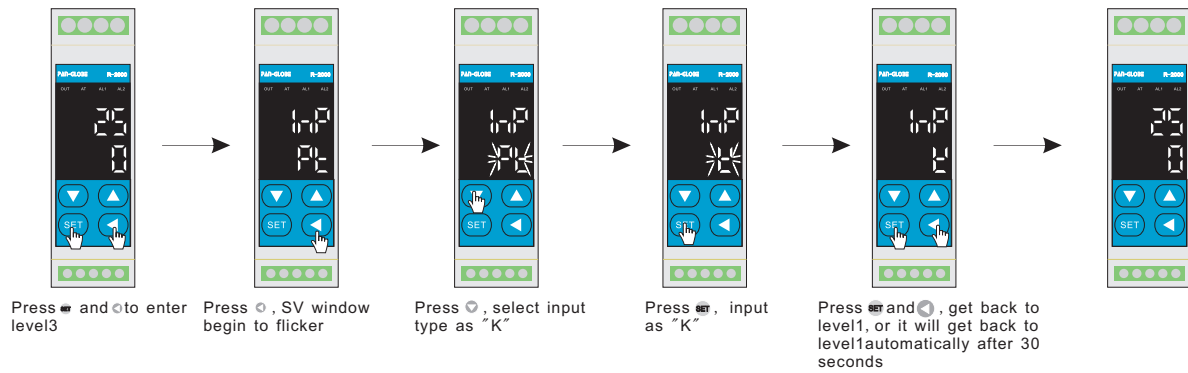

SV value setting

i.e., SV=200, operation as below:

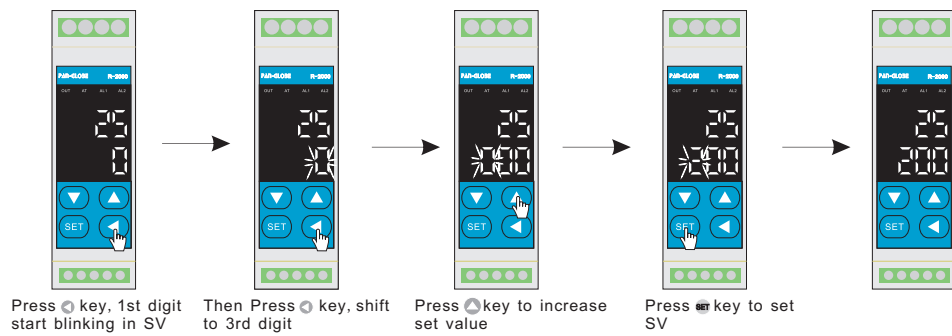

Auto Tuning

Please set PID in excellent manner to achieve the best controlling result, operate as following:

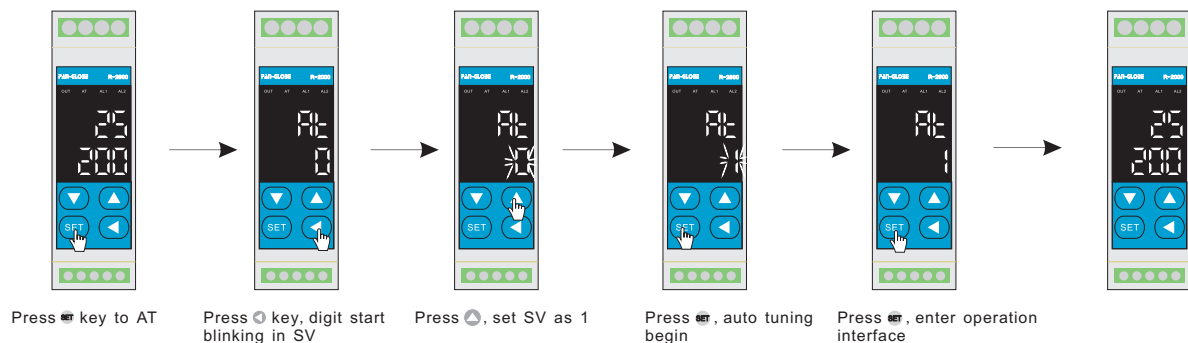

alarm settin

i.e.: setting Deviation high alarm mode, alarm value AL1=5, when PV is higher than SV+5, alarm 1 act(AD1=0, Deviation high alarm)

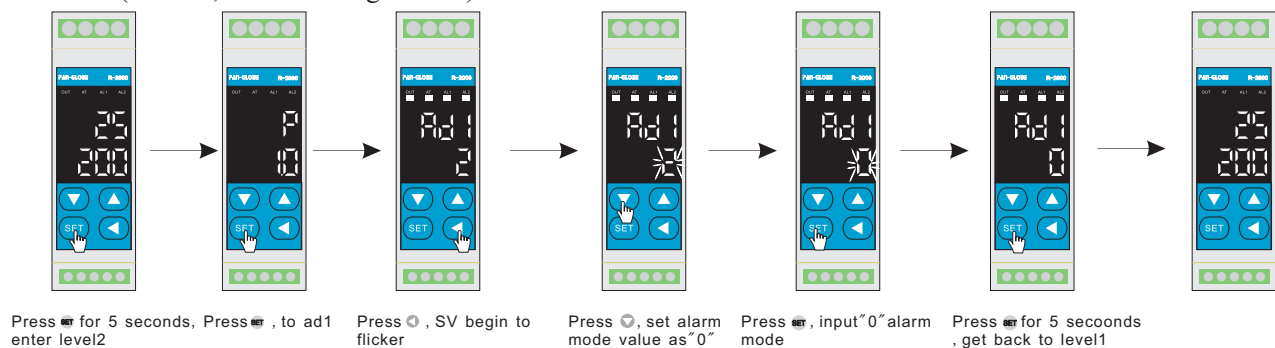

6 ordering information

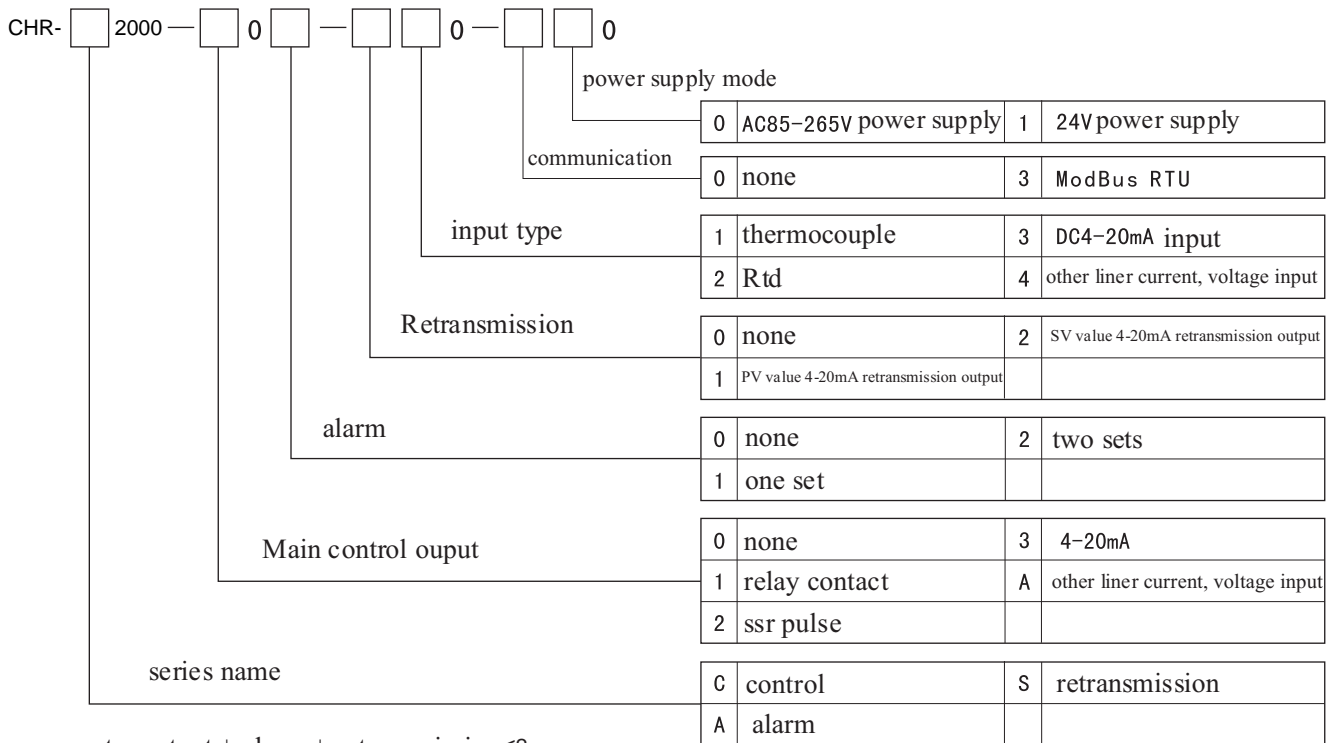

It has 2 sets of alarm most, users can set alarm mode according to their needs, please check the parameters of each alarm mode in below table:

alarm 1	alarm 2	Instruction
AL1	AL2	Alarm value setting: can be Deviation or Absolute value, according to different alarm mode
AD1	AD2	Alarm mode, please refer to << alarm mode index >>
HY1	HY2	Alarm hysteresis

Alarm mode index

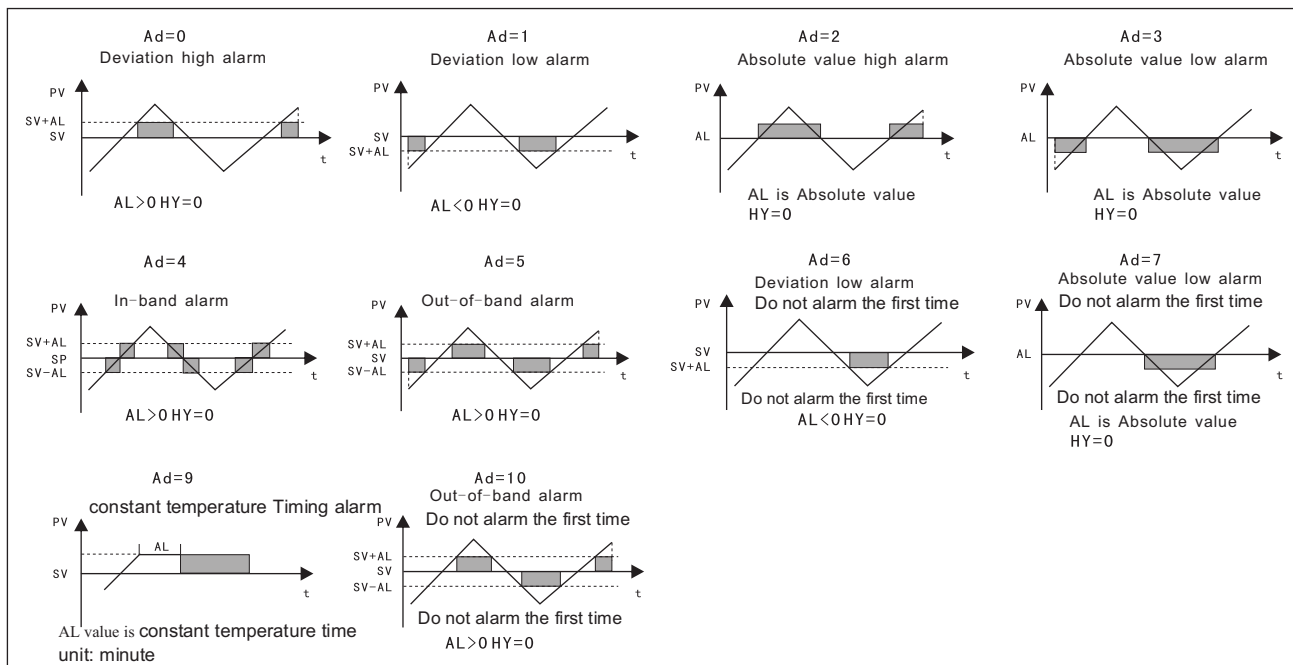

7 Technical Specification

Standard products specification	
Model	CHR-2000
Size	225×75×945mm
Power voltage	AC85~265V, DC24V (optional)
Power frequency	50/60HZ
Power consumption	About 4VA
Memory	Power disconnection preserve memory E ² PROM
Input	Sensing signal input. Sampling time: 150ms, display accuracy: 0.5% of FS
	Thermocouples (TC) K, J, R, S, B, E, N, T, W
	Thermal Resistance (RTD) PT100, CU50
	Linear current (mA) 4~20mA, 0~20mA, others
	Linear voltage (mV, V) 0~1V, 0~5V, 0~10V, 1~5V, 2~10V, -10~10mV, 0~10mV, 0~20mV, 0~50mV, 10~50mV others
Output1	Control output (can set at HEAT mode or COOL mode)
	(Relay) 5A, 220V, Electric lift : 100,000 Times or more (under rated load)
	Linear current (mA) 4~20mA, 0~20mA. Largest loading impedance: 900Ω
	Linear voltage (mV, V) 0~5V, 0~10V, 1~5V, 2~10V. Largest loading current: 20mA.
Alarm (Relay)	5A, 220V, Electric lift 100,000 Times or more (under rated load)
Control mode	PID, P, PI, PD, ON/OFF (P=0)
PID set range	P: 0~200% , I : 0~3600秒, D : 0~900秒
Insulation	Control loop (control loop, alarm, transit output) and input loop insulare absolutly
Insulation resistance	Main loop-crust (ground) DC500V>10MΩ , Control loop-crust (ground) DC500V>10MΩ
Voltage resistance	Main loop-crust (ground) 1500Vper minite, control loop-crust (ground) 1000Vper minite
Operating temperature	-10~50°C
Operating ambience	0~85%RH
Weight	About 15g

Optional function specification	
Model	CHR-2000
Output2	Control output (can set at HEAT mode or COOL mode)
	(Relay) 5A, 220V, Electric lift : 100,000 Times or more (under rated load)
	SSR SSR pulse. ON:24V, OFF:0V, Max. load current: 20mA
	Linear current (mA) 4~20mA, 0~20mA. Largest loading impedance: 900Ω
	Linear voltage (mV, V) 0~5V, 0~10V, 1~5V, 2~10V. Largest loading current: 20mA.
Alarm (Relay)	5A, 220V, Electric lift 100,000 Times or more (under rated load)
Retransmission	Can transmit PV, SV
	Current output 4~20mA, 0~20mA. Largest loading impedance: 900Ω
	Voltage output 0~5V, 0~10V, 1~5V, 2~10V. Largest loading current: 20mA.
Communication	ModBus RTU
	Communication rate: 9600, 19200

8 Parameter specification of each level

Parameter setup

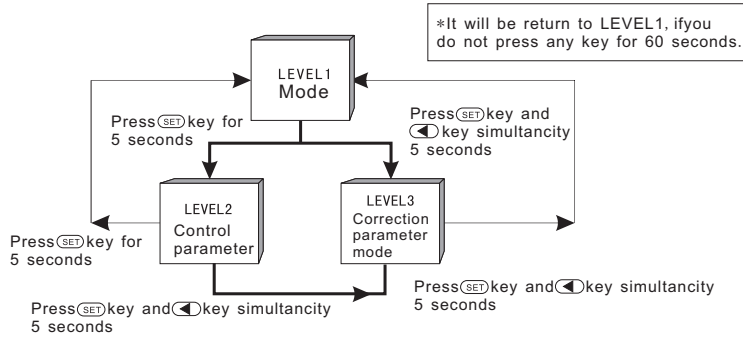

LEVEL1	Mode	LEVEL2	Control parameter	LEVEL3	Correction parameter mode
POWER ON		P	Proportion band of group1(%) P=0 is ON/OFF	InP	Input type set, please refer to application example1
Self-diagnostic	Indicator Lighting	3		LSP	Lower limit for sv
InP		↓ Set		0	
0	Input type	1	Integral1 time (s) I=0 is OFF	USP	Upper limit for sv
400	Input range	200		400	
↓ Set		↓ Set	Differential coefficient1 time (s) D=0 is OFF	↓ Set	
25	PV/SV value display (setting SV value)	d	0: heating 1: colling	00	Input zero adjustment
0		10		00	
↓ Set		↓ Set	Output1 hysteresis set	00	
00	Output display	0.1	Working cycle of group1 (s) 0: mA, 1: SSR, others are relay output	00	Output zero adjustment
↓ Set		↓ Set	Alarm1 hysteresis set	00	
00	Auto tuning 1: AT on 2: AT off	0.1		00	Output span adjustment
↓ Set		↓ Set	Alarm1 mode set	00	
0	Alarm1 set	0.1	Alarm2 hysteresis set	00	Factory calibration only
↓ Set		↓ Set	Alarm2 mode set	00	
0	Alarm1 set	0.1	Proportion band of group2(%) P1=0 is ON/OFF	00	Factory calibration only
↓ Set		↓ Set	Integral2 time (s) I1=0 is OFF	00	
0	Cooling SV1=SV+GAP (Only dual output)	0.1	Differential coefficient2 time (s) D1=0 is OFF	00	Transmission output range lower limit setting
↓ Set		↓ Set	Working cycle of group2 (s) 0: mA, 1: SSR, others are relay output	00	
0	Ramp temperature set RTM=0, ramp off	0.1	Output low limit	00	Transmission output range upper limit setting
↓ Set		↓ Set	Output high limit	00	
0	Ramp time set RTM=0, ramp off	0.1	0: manual enable 1: manual inhibit	00	Temperature correction (main input quantities correction) the decimal point and synchronized Bandrate 1: 9600 2: 19200
↓ Set		↓ Set	DATA LOCK 000: can modify all parameters 010: LEVEL2, LEVEL3 all parameters cant be modified	00	Communication address
LEVEL2		LEVEL3		0-30	